

# CUBE

---

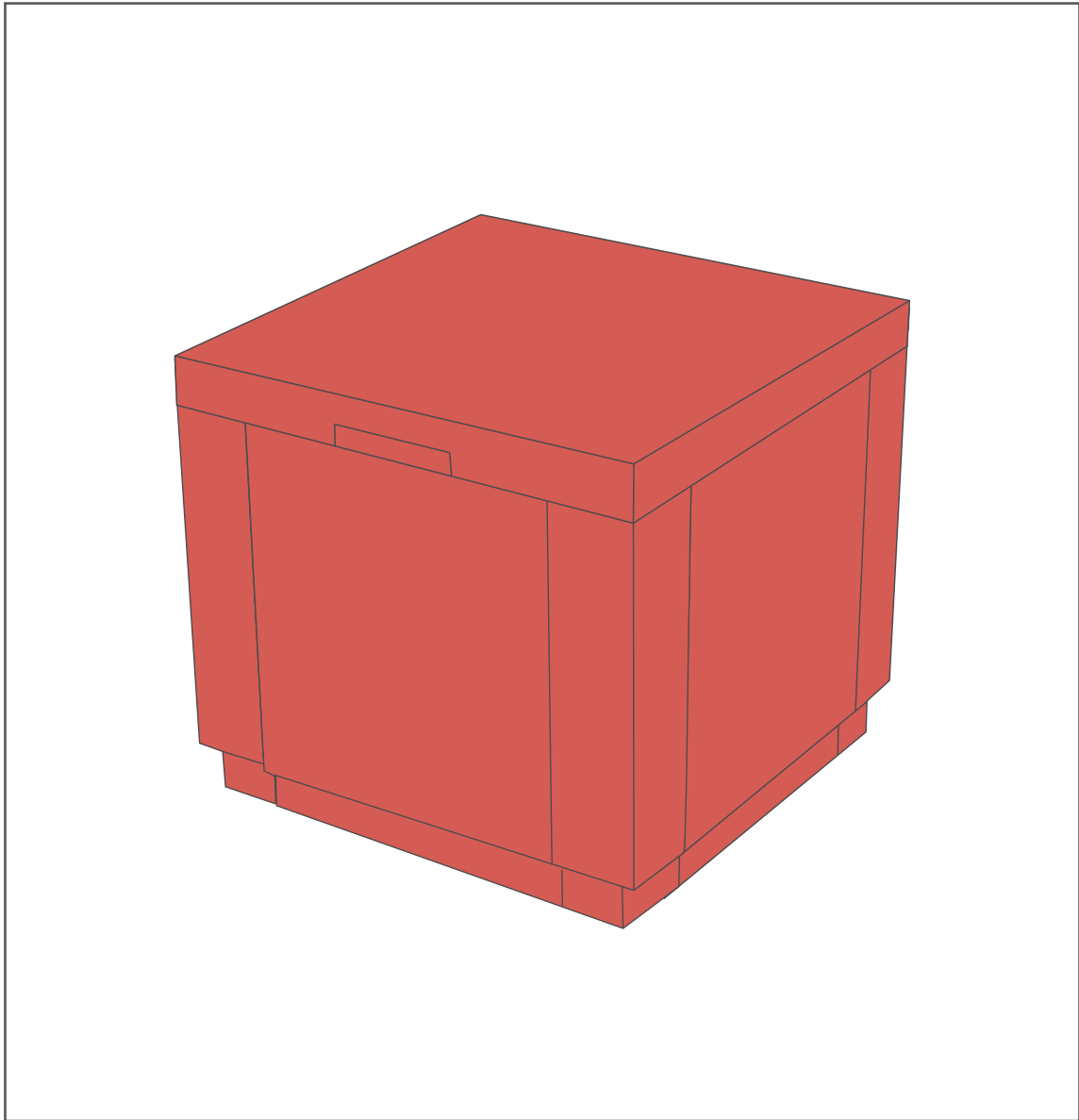

"CUBE" V0.4 / 543268 / 442000



543268



NEN 581

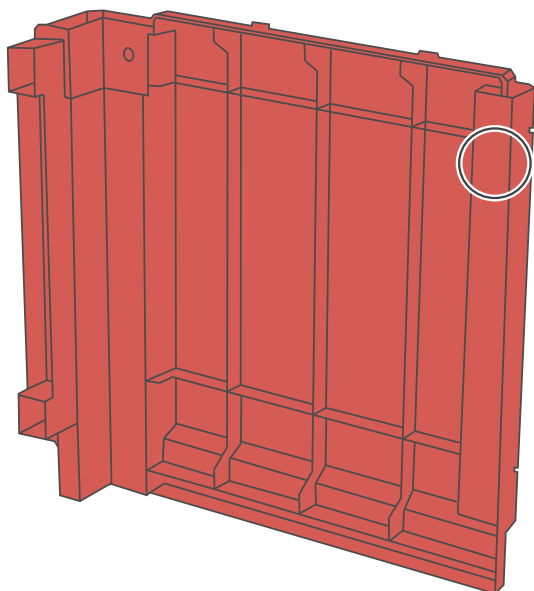

CS (4x)

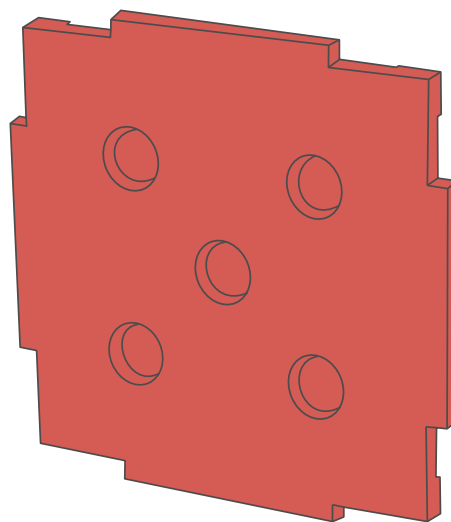

CB (1x)

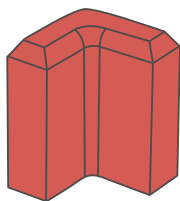

B (4x)

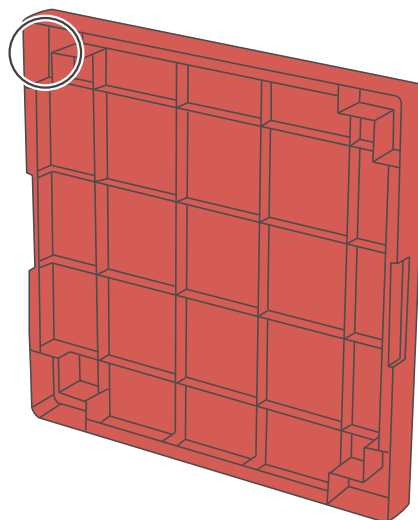

CL (1x)

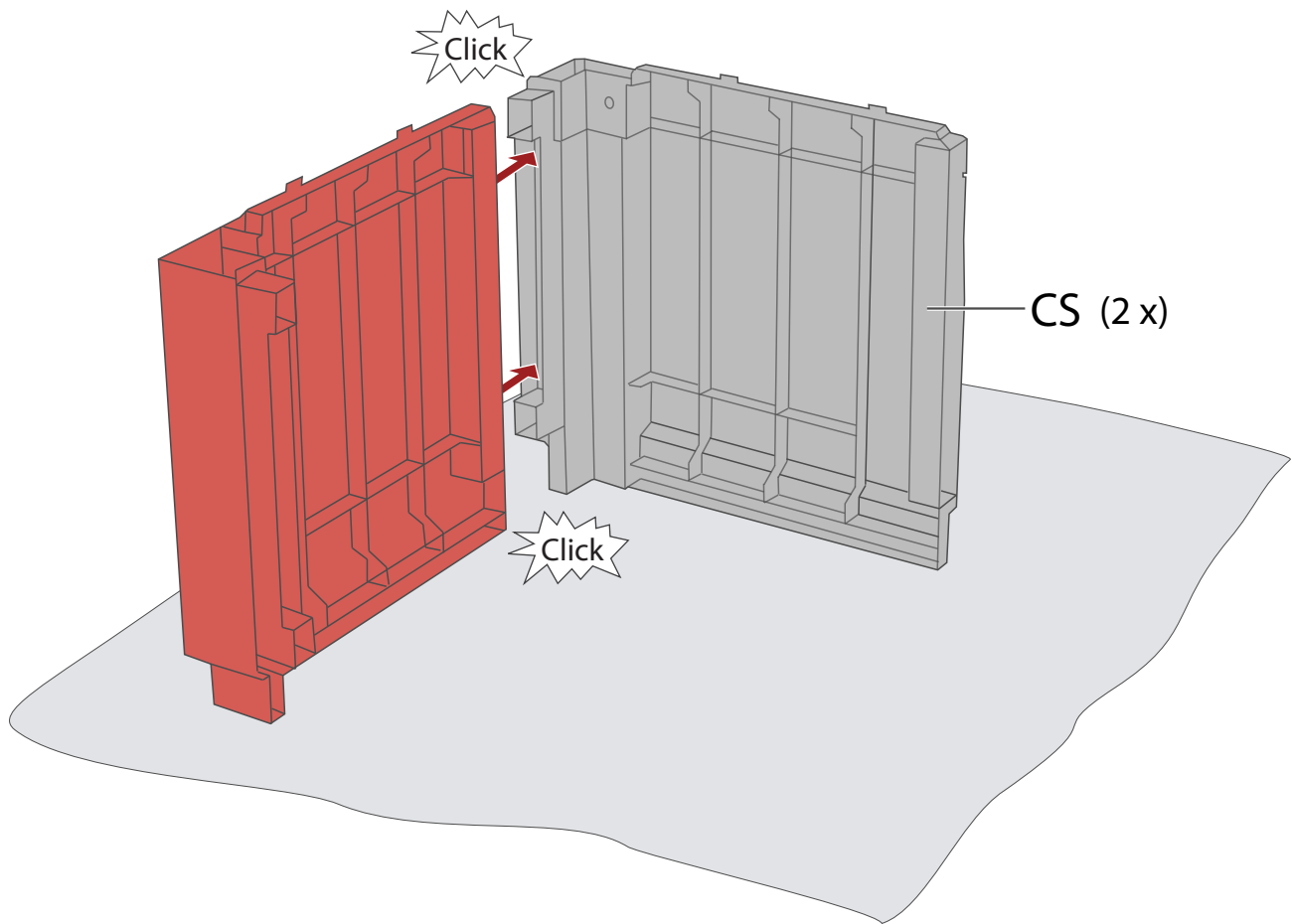

1

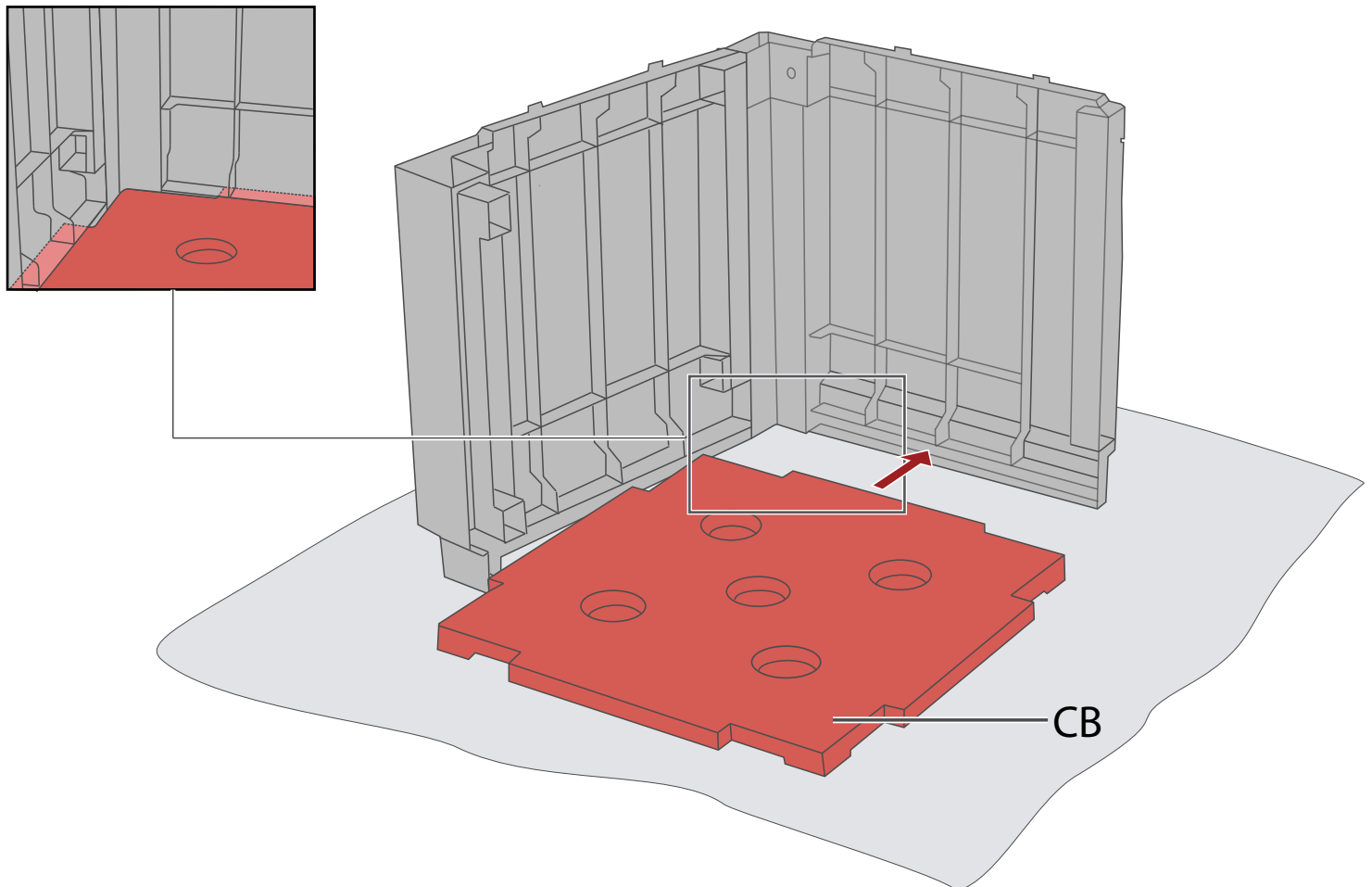

2

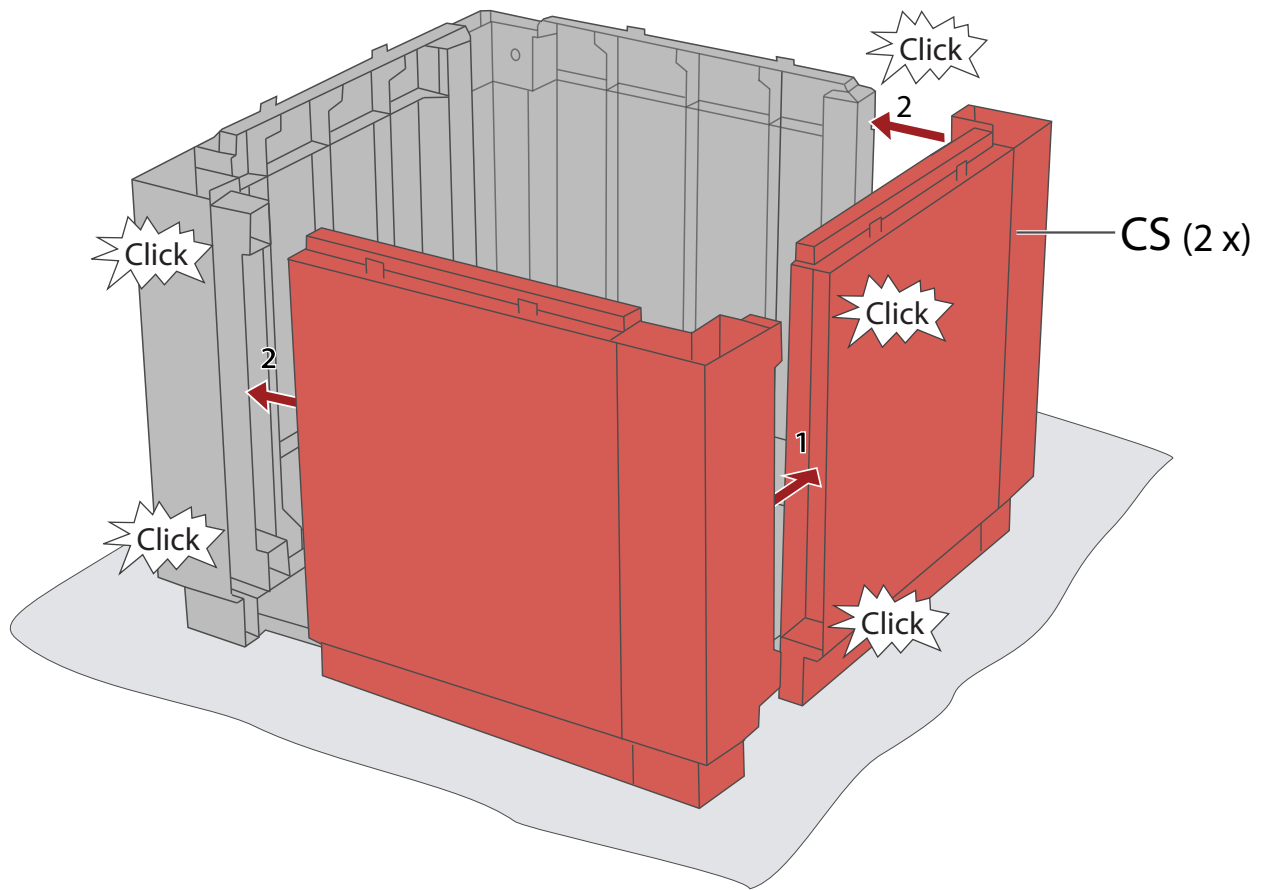

3

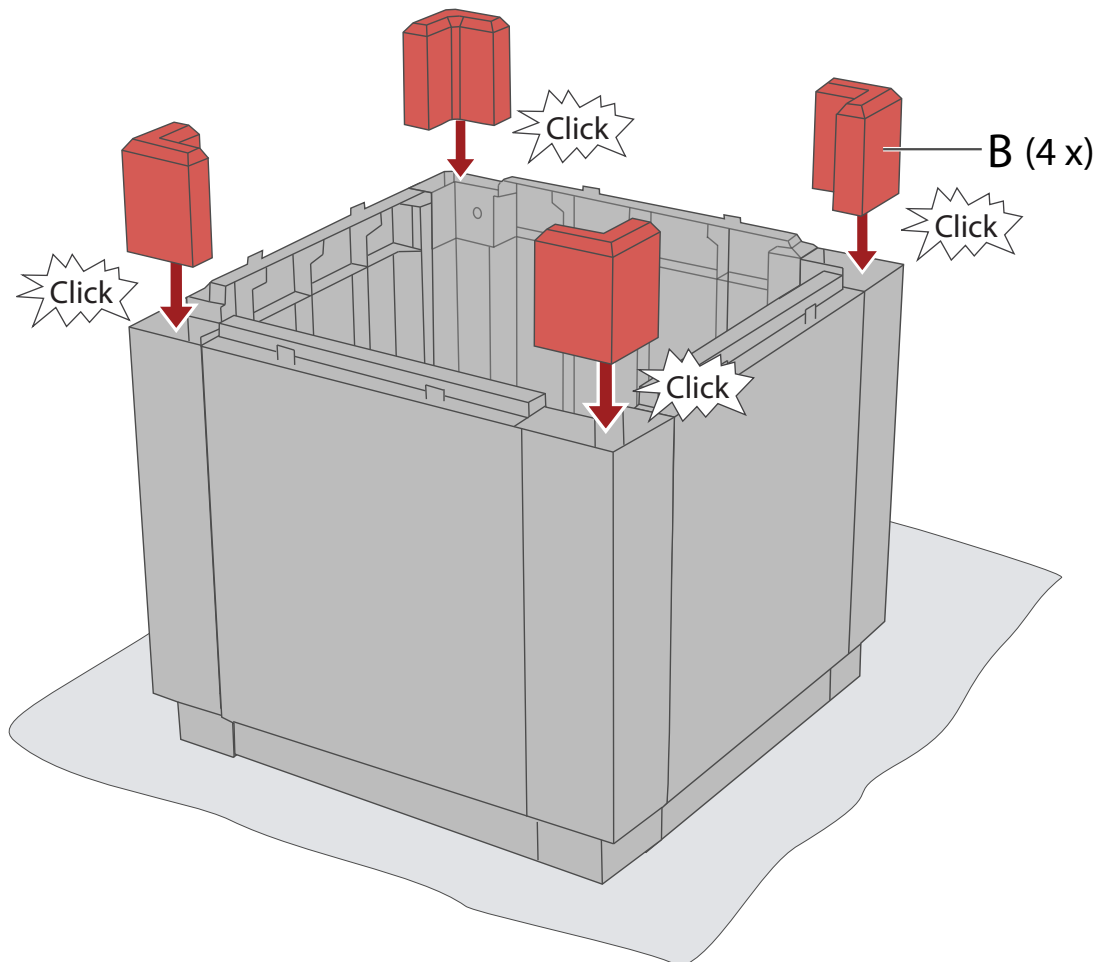

4

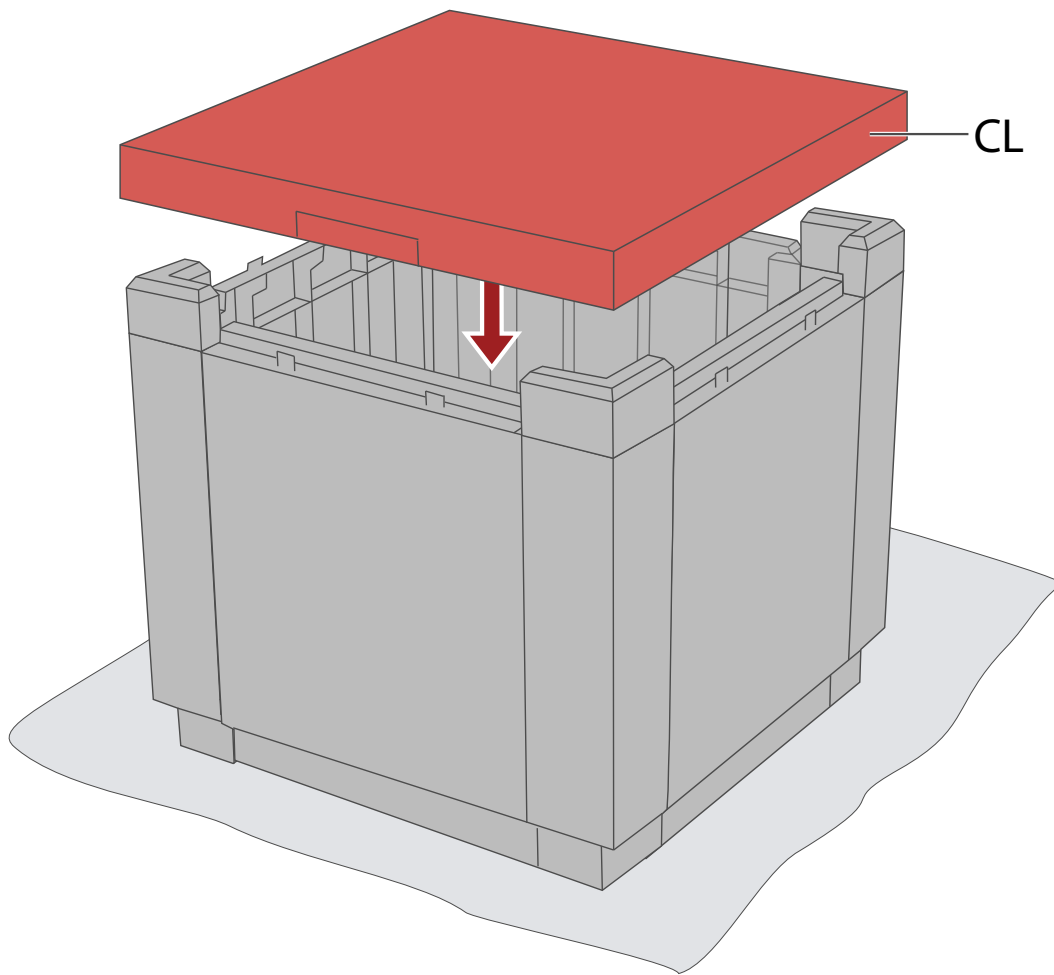

5

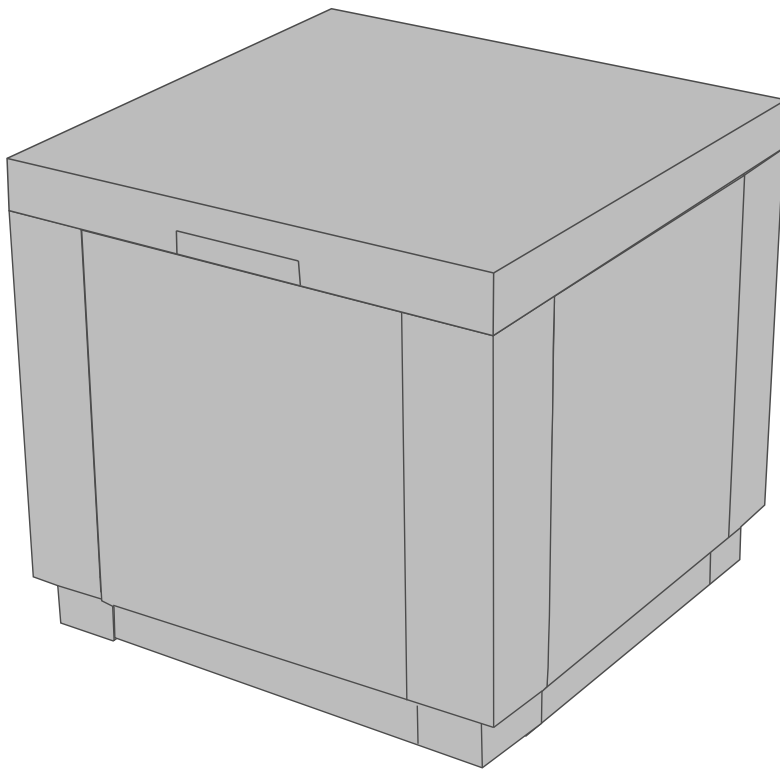

6